

## Kettenradscheibe

### 6 x 2,8 mm

für Rollenkette nach DIN 8187

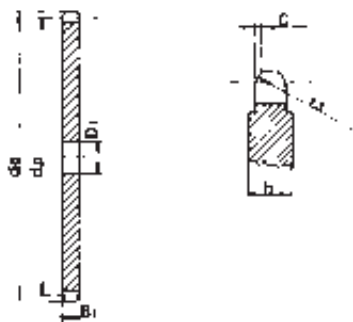

Teilung = 6 mm  
Rollen  $\varnothing$  = 4 mm  
r3 = 6 mm  
C = 0,7 mm  
B1 = 2,6 mm

Material: Fe 50

Z	de	dp	Einf.			Zwei.			Drei.		
			D1	D2	D3	D1	D2	D3	D1	D2	D3
8	18,0	15,67	5								
9	19,9	17,54	5								
10	21,7	19,42	6								
11	23,6	21,30	6								
12	25,4	23,18	6								
13	27,3	25,05	8								
14	29,2	26,96	8								
15	31,0	28,86	8								
16	33,0	30,76	8								
17	35,0	32,65	8								
18	36,9	34,55	8								
19	38,8	36,44	8								
20	40,7	38,34	8								
21	42,6	40,25	8								
22	44,5	42,16	8								
23	46,4	44,06	8								
24	48,3	45,96	8								
25	50,2	47,87	8								
26	52,1	49,76	8								
27	54,0	51,67	8								
28	55,9	53,58	8								
29	57,8	55,50	8								
30	59,8	57,42	8								
31	61,7	59,31	8								
32	63,6	61,21	8								
33	65,5	63,11	8								
34	67,4	65,02	8								
35	69,3	66,93	8								
36	71,2	68,84	8								
37	73,1	70,75	8								
38	75,0	72,66	8								
39	76,9	74,57	8								
40	78,9	76,47	8								
41	80,8	78,38	10								
42	82,7	80,28	10								
43	84,7	82,19	10								
44	86,6	84,10	10								
45	88,5	86,01	10								
46	90,4	87,92	10								
47	92,3	89,93	10								
48	94,2	91,74	10								
49	96,1	93,64	10								
50	98,0	95,55	10								
51	99,9	97,46	12								
52	101,8	99,37	12								
53	103,7	101,27	12								
54	105,6	103,17	12								
55	107,6	105,08	12								
56	109,5	107,00	12								
57	111,4	108,93	12								
58	113,3	110,82	12								
59	115,2	112,71	12								
60	117,1	114,62	12								
62	120,9	118,45	14								
64	124,7	122,27	14								
65	126,6	124,18	14								
66	128,5	126,09	14								
68	132,4	129,91	14								
70	136,2	133,73	14								
72	140,0	137,55	16								
75	145,7	143,28	16								
76	147,6	145,19	16								
78	151,5	149,01	16								
80	155,3	152,82	16								
85	164,8	162,37	16								
90	174,4	171,92	16								
95	183,9	181,47	16								
100	193,5	191,01	16								
110	212,6	210,11	16								
114	220,2	217,75	16								
120	231,7	229,20	16								
125	241,2	238,75	16								

Bestell-Nr. zzgl. Zähnezahl

Einfach

4 1 7 0 0 6

Beispiel

4 1 7 0 0 6 0 1 0

[www.tewa-antriebstechnik.de](http://www.tewa-antriebstechnik.de)

# Kettenradscheibe

## 8 x 3 mm

für Rollenkette nach DIN 8187

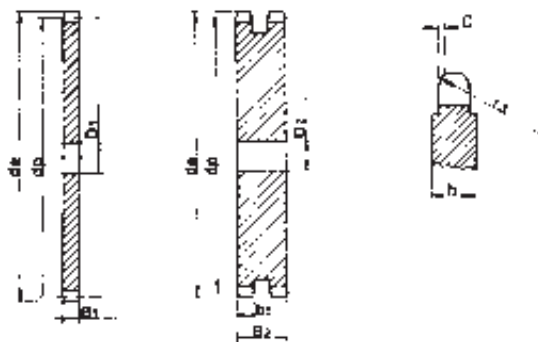

- Teilung** = 8 mm
- Rollen ø** = 5 mm
- r3** = 8 mm
- C** = 1,0 mm
- B1** = 2,8 mm
- b1** = 2,7 mm
- B2** = 8,3 mm

Material: C43

Z	de	dp	Einf.			Zwei.			Drei.		
			D1	D2	D3	D1	D2	D3	D1	D2	D3
8	24,0	20,90	6	6							
9	26,6	23,39	6	6							
10	29,2	25,89	8	8							
11	31,7	28,39	8	8							
12	34,2	30,91	8	8							
13	36,7	33,42	8	8							
14	39,2	35,95	8	B							
15	41,7	38,48	8	8							
16	44,3	41,01	8	10							
17	46,8	43,53	8	10							
18	49,3	46,07	8	10							
19	51,9	48,61	8	10							
20	54,4	51,14	8	10							
21	57,0	53,68	8	10							
22	59,5	56,21	8	10							
23	62,0	58,75	8	10							
24	64,6	61,29	8	10							
25	67,5	63,83	8	10							
26	69,5	66,37	10	12							
27	72,2	68,91	10	12							
28	74,8	71,45	10	12							
29	77,3	73,99	10	12							
30	79,8	76,53	10	12							
31	82,4	79,08	10	12							
32	84,9	81,61	10	12							
33	87,5	84,16	10	12							
34	90,0	86,70	10	12							
35	92,5	89,25	10	12							
36	95,0	91,79	10	12							
37	97,6	94,33	10	12							
38	100,2	96,88	10	12							
39	102,7	99,42	10	12							
40	105,3	101,97	10	12							
41	107,8	104,51	12	14							
42	110,4	107,05	12	14							
43	112,9	109,60	12	14							
44	115,5	112,14	12	14							
45	118,0	114,69	12	14							
46	120,6	117,23	12	14							
47	123,1	119,77	12	14							
48	125,6	122,32	12	14							
49	128,2	124,86	12	14							
60	130,7	127,41	12	14							
51	133,3	129,95	14	16							
62	135,8	132,49	14	16							
53	138,4	135,04	14	16							
64	140,9	137,59	14	16							
55	143,5	140,13	14	16							
56	146,0	142,68	14	16							
57	148,6	145,22	14	16							
58	151,0	147,77	14	16							
59	153,6	150,31	14	16							
60	156,2	152,85	14	16							
62	162,0	157,95	16	20							
64	167,1	163,04	16	20							
65	169,6	165,58	16	20							
66	172,2	168,13	16	20							
68	177,3	173,22	16	20							
70	182,4	178,31	16	20							
72	187,5	183,41	20	20							
75	195,1	191,04	20	20							
76	197,7	193,59	20	20							
78	202,8	198,68	20	20							
80	207,9	203,77	20	20							
85	220,6	216,50	20	20							
90	233,4	229,23	20	20							
95	246,1	241,96	20	20							
100	258,9	254,68	20	20							
110	284,3	280,15	20	20							
114	294,5	290,33	20	20							
120	310,0	305,61	20	20							
125	322,5	318,34	20	20							

Bestell-Nr. zzgl. Zähnezahl

Einfach

4 1 7 0 0 8

Zweifach

4 2 7 0 0 8

Beispiel

4 2 7 0 0 8 0 1 0

## Kettenradscheibe

### 3/8" x 7/32"

für Rollenkette  
nach DIN 8187

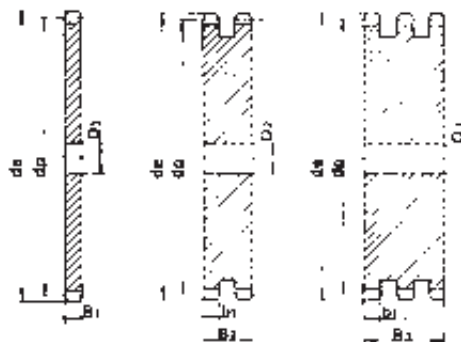

- Teilung = 9,525 mm
- Rollen ø = 6,35 mm
- r3 = 10 mm
- C = 1,0 mm
- B1 = 5,3 mm
- b1 = 5,2 mm
- B2 = 15,4 mm
- B3 = 25,6 mm

Material: C43

Z	de	dp	Einf.			Zwei.			Drei.		
			D1	D2	D3	D1	D2	D3	D1	D2	D3
8	28,0	24,89	6	6	6	44	137,6	133,52	16	16	16
9	31,0	27,85	7	8	8	45	140,7	136,55	16	16	16
10	34,0	30,82	7	8	10	46	143,7	139,58	16	16	16
11	37,0	33,80	8	10	10	47	146,7	142,61	16	16	16
12	40,0	36,80	8	10	10	48	149,7	145,64	16	16	16
13	43,0	39,79	8	10	10	49	152,7	148,66	16	16	16
14	46,3	42,80	8	10	12	50	155,7	151,69	16	16	16
15	49,3	45,81	8	10	12	51	158,7	154,72	16	16	20
16	52,3	48,82	10	12	12	52	161,8	157,75	16	16	20
17	55,3	51,83	10	12	12	53	164,8	160,78	16	16	20
18	58,3	54,85	10	12	12	54	167,8	163,82	16	16	20
19	61,3	57,87	10	12	12	55	170,8	166,85	16	16	20
20	64,3	60,89	10	12	12	56	173,8	169,88	16	16	20
21	68,0	63,91	10	12	14	57	176,9	172,91	16	16	20
22	71,0	66,93	10	12	14	58	179,9	175,93	16	16	20
23	73,5	69,95	10	12	14	59	183,0	178,96	16	16	20
24	77,0	72,97	10	12	14	60	186,0	181,99	16	16	20
25	80,0	76,02	10	12	14	62	192,1	188,06	20	20	20
26	83,0	79,02	10	12	14	64	198,2	194,12	20	20	20
27	86,0	82,02	10	12	14	65	201,6	197,15	20	20	20
28	89,0	85,07	10	12	14	66	204,6	200,18	20	20	25
29	92,0	88,09	10	12	14	68	210,7	206,24	20	20	25
30	94,7	91,12	10	12	14	70	216,7	212,30	20	20	25
31	98,3	94,15	12	14	16	72	222,8	218,37	20	20	25
32	101,3	97,17	12	14	16	75	231,9	227,46	20	20	25
33	104,3	100,20	12	14	16	76	234,9	230,49	20	20	25
34	107,3	103,23	12	14	16	78	241,0	236,55	20	20	25
35	110,4	106,26	12	14	16	80	247,1	242,61	20	20	25
36	113,4	109,20	12	14	16	85	262,2	257,77	20	20	25
37	116,4	112,32	12	14	16	90	277,4	272,93	20	20	25
38	119,5	115,35	12	14	16	95	292,5	288,08	20	20	25
39	122,5	118,37	12	14	16	100	307,7	303,25	20	20	25
40	125,5	121,40	12	14	16	110	338,0	333,55	20	20	25
41	128,5	124,43	16	16	16	114	349,5	345,68	20	20	25
42	131,6	127,46	16	16	16	120	368,3	363,86	20	20	25
43	134,6	130,49	16	16	16	125	383,5	379,02	20	20	25

Bestell-Nr. zzgl. Zähnezahl

Einfach

4 1 7 0 1 0

Zweifach

4 2 7 0 1 0

Dreifach

4 3 7 0 1 0

Beispiel

4 1 7 0 1 0 0 1 0

## Kettenradscheibe

### 1/2" x 5/16"

für Rollenkette  
nach DIN 8187

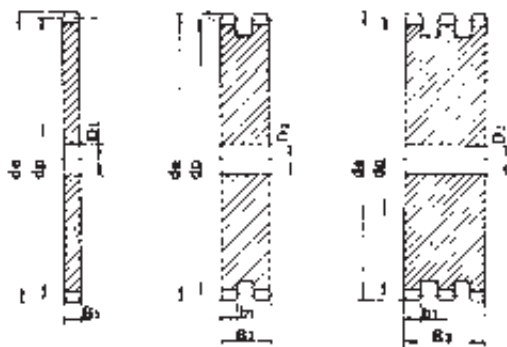

Teilung = 12,7 mm  
Rollen  $\varnothing$  = 8,51 mm  
r3 = 13 mm  
C = 1,3 mm  
B1 = 7,2 mm  
b1 = 7 mm  
B2 = 21 mm  
B3 = 34,9 mm

Material: C 43

Z	de	dp	Einf.			Zwei.			Drei.		
			D1	D2	D3	D1	D2	D3	D1	D2	D3
8	37,2	33,18	8	10	10	44	183,8	178,03	20	20	25
9	41,0	37,13	8	10	12	45	188,0	182,07	20	20	25
10	45,2	41,10	8	10	12	46	192,1	186,10	20	20	25
11	48,7	45,07	10	12	14	47	196,2	190,14	20	20	25
12	53,0	49,07	10	12	14	48	200,3	194,18	20	20	25
13	57,4	53,06	10	12	14	49	204,3	198,22	20	20	25
14	61,8	57,07	10	12	14	50	208,3	202,26	20	20	25
15	65,5	61,09	10	12	14	51	212,1	206,30	20	25	25
16	69,5	65,10	10	14	16	52	216,1	210,34	20	25	25
17	73,6	69,11	10	14	16	53	220,2	214,37	20	25	25
18	77,8	73,14	10	14	16	54	224,1	218,43	20	25	25
19	81,7	77,16	10	14	16	55	228,1	222,46	20	25	25
20	85,8	81,19	10	14	16	56	232,2	226,50	20	25	25
21	89,7	85,22	12	16	20	57	236,4	230,54	20	25	25
22	93,8	89,24	12	16	20	58	240,5	234,58	20	25	25
23	98,2	93,27	12	16	20	59	244,5	238,62	20	25	25
24	101,8	97,29	12	16	20	60	248,6	242,66	20	25	25
25	105,8	101,33	12	16	20	62	256,9	250,75	25	25	25
26	110,0	105,36	16	16	20	64	265,1	258,82	25	25	25
27	114,0	109,40	16	16	20	65	269,0	262,86	25	25	25
28	118,0	113,42	16	16	20	66	273,0	266,90	25	25	25
29	122,0	117,46	16	16	20	68	281,0	274,99	25	25	25
30	126,1	121,50	16	16	20	70	289,0	283,07	25	25	25
31	130,2	125,54	16	16	20	72	297,2	291,16	25	25	25
32	134,3	129,56	16	16	20	75	309,2	303,27	25	25	25
33	138,4	133,60	16	16	20	76	313,3	307,33	25	25	25
34	142,6	137,64	16	16	20	78	321,4	315,40	25	25	25
35	146,7	141,68	16	16	20	80	329,4	323,48	25	25	25
36	151,0	145,72	16	20	25	85	349,0	343,70	25	25	25
37	154,6	149,76	16	20	25	90	369,9	363,90	25	25	25
38	158,6	153,80	16	20	25	95	390,1	384,11	25	25	25
39	162,7	157,83	16	20	25	100	410,3	404,32	25	25	25
40	166,8	161,87	16	20	25	110	450,7	444,74	25	25	25
41	171,4	165,91	20	20	25	114	466,9	460,90	25	25	25
42	175,4	169,95	20	20	25	120	491,2	485,16	25	25	25
43	179,7	173,99	20	20	25	125	511,3	505,37	25	25	25

Bestell-Nr. zzgl. Zähnezahl

Einfach

4 1 7 0 1 1

Zweifach

4 2 7 0 1 1

Dreifach

4 3 7 0 1 1

Beispiel

4 1 7 0 1 1 0 1 0

## Kettenradscheibe

5/8" x 3/8"

für Rollenkette  
nach DIN 8187

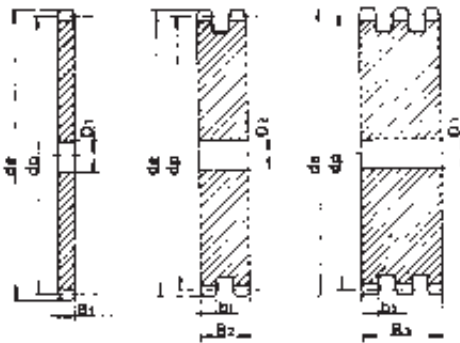

Teilung = 15,875 mm  
 Rollen ø = 10,16 mm  
 r3 = 16 mm  
 C = 1,6 mm  
 B1 = 9,1 mm  
 b1 = 9 mm  
 B2 = 25,5 mm  
 B3 = 42,1 mm

Material: C 43

Z	de	dp	Einf.			Zwei.			Drei.		
			D1	D2	D3	D1	D2	D3	D1	D2	D3
8	47,0	41,48	10	12	12	44	230,0	222,53	20	20	25
9	52,6	46,42	10	12	12	45	235,0	227,58	20	20	25
10	57,5	51,37	10	12	16	46	240,1	232,63	20	25	25
11	63,0	56,34	10	14	16	47	245,1	237,68	20	25	25
12	68,0	61,34	10	14	16	48	250,2	242,73	20	25	25
13	73,0	66,32	10	14	16	49	255,2	247,78	20	25	25
14	78,0	71,34	10	14	16	50	260,3	252,82	20	25	25
15	83,0	76,36	10	14	16	51	265,3	257,87	20	25	25
16	88,0	81,37	12	16	16	52	270,4	262,92	20	25	25
17	93,0	86,38	12	16	16	53	275,4	267,97	20	25	25
18	98,3	91,42	12	16	16	54	280,5	273,03	20	25	25
19	103,3	96,45	12	16	16	55	285,5	278,08	20	25	25
20	108,4	101,49	12	16	16	56	290,6	283,13	25	25	25
21	113,4	106,52	12	16	20	57	296,0	288,18	25	25	25
22	118,0	111,55	12	16	20	58	300,7	293,23	25	25	25
23	123,5	116,58	12	16	20	59	305,7	298,27	25	25	25
24	128,3	121,62	12	16	20	60	310,8	303,32	25	25	25
25	134,0	126,66	12	16	20	62	321,4	313,43	25	25	30
26	139,0	131,70	16	16	20	64	331,5	323,53	25	25	30
27	144,0	136,75	16	16	20	65	336,5	328,58	25	25	30
28	148,7	141,78	16	16	20	66	341,6	333,63	25	25	30
29	153,8	146,83	16	16	20	68	351,7	343,74	25	25	30
30	158,8	151,87	16	16	20	70	361,8	353,84	25	25	30
31	163,9	156,92	16	20	20	72	371,9	363,95	25	25	30
32	168,9	161,95	16	20	20	75	387,1	379,09	25	25	30
33	174,5	167,00	16	20	20	76	392,1	384,16	25	25	30
34	179,0	172,05	16	20	20	78	402,2	394,25	25	25	30
35	184,1	177,10	16	20	20	80	412,3	404,35	25	30	30
36	189,1	182,15	20	20	25	85	437,6	429,62	30	30	30
37	194,2	187,20	20	20	25	90	462,8	454,88	30	30	30
38	199,2	192,24	20	20	25	95	488,5	480,14	30	30	30
39	204,2	197,29	20	20	25	100	513,4	505,39	30	30	30
40	209,3	202,34	20	20	25	110	563,9	555,92	30	30	30
41	214,8	207,39	20	20	25	114	584,1	576,13	30	30	30
42	219,9	212,44	20	20	25	120	614,4	606,45	30	30	30
43	224,9	217,49	20	20	25	125	639,7	631,51	30	30	30

Bestell-Nr. zzgl. Zähnezahl

Einfach

4 1 7 0 1 2

Zweifach

4 2 7 0 1 2

Dreifach

4 3 7 0 1 2

Beispiel

4 1 7 0 1 2 0 1 0

# Kettenradscheibe

## 3/4" x 7/16"

für Rollenkette  
nach DIN 8187

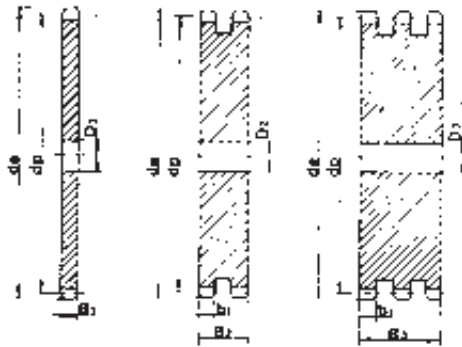
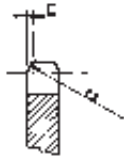

- Teilung = 19,05 mm
- Rollen ø = 12,07 mm
- r3 = 19 mm
- C = 2 mm
- B1 = 11,1 mm
- b1 = 10,8 mm
- B2 = 30,3 mm
- B3 = 49,8 mm

Material: C 43

Z	de	dp	Einf.			Zwei.			Drei.		
			D1	D2	D3	D1	D2	D3	D1	D2	D3
8	57,6	49,78	12	12	16	44	276,5	267,04	25	25	25
9	62,0	55,70	12	12	16	45	282,5	273,10	25	25	25
10	69,0	61,64	12	12	16	46	287,9	279,16	25	25	25
11	75,0	67,61	14	16	20	47	294,0	285,21	25	25	25
12	81,5	73,61	14	16	20	48	300,1	291,27	25	25	25
13	87,5	79,59	14	16	20	49	306,2	297,33	25	25	25
14	93,6	85,61	14	16	20	50	312,3	303,39	25	25	25
15	99,8	91,63	14	16	20	51	318,4	309,45	25	25	25
16	105,5	97,65	14	20	20	52	324,5	315,50	25	25	25
17	111,5	103,67	14	20	20	53	330,5	321,56	25	25	25
18	118,0	109,71	14	20	20	54	336,6	327,64	25	25	25
19	124,2	115,75	14	20	20	55	342,7	333,70	25	25	25
20	129,7	121,78	14	20	20	56	348,7	339,75	25	25	30
21	136,0	127,82	16	20	20	57	355,4	345,81	25	25	30
22	141,8	133,86	16	20	20	58	361,5	351,87	25	25	30
23	149,0	139,90	16	20	20	59	367,5	357,93	25	25	30
24	153,9	145,94	16	20	20	60	373,0	363,99	25	25	30
25	160,0	152,00	16	20	20	62	385,1	376,12	25	30	30
26	165,9	158,04	16	20	20	64	397,2	388,24	25	30	30
27	172,3	164,09	16	20	20	65	403,2	394,29	25	30	30
28	178,0	170,13	16	20	20	66	409,3	400,35	30	30	30
29	184,1	176,19	16	20	20	68	421,4	412,49	30	30	30
30	190,5	182,25	16	20	20	70	433,6	424,60	30	30	30
31	196,3	188,31	20	20	25	72	447,0	436,74	30	30	30
32	203,3	194,36	20	20	25	75	463,9	454,91	30	30	30
33	209,2	200,40	20	20	25	76	469,9	460,99	30	30	30
34	214,6	206,46	20	20	25	78	482,1	473,10	30	30	30
35	221,0	212,52	20	20	25	80	494,2	485,22	30	30	30
36	226,8	218,58	20	25	25	85	524,5	515,55	30	30	30
37	232,9	224,64	20	25	25	90	554,8	545,86	30	30	30
38	239,0	230,69	20	25	25	95	585,1	576,17	30	30	30
39	245,1	236,75	20	25	25	100	615,4	606,47	30	30	30
40	251,3	242,81	20	25	25	110	676,1	667,11	30	30	30
41	257,3	248,87	25	25	25	114	700,6	691,36	30	30	30
42	264,5	254,93	25	25	25	120	736,7	727,74	30	30	30
43	270,5	260,98	25	25	25	125	767,0	758,05	30	30	30

Bestell-Nr. zzgl. Zähnezahl

Einfach

4 1 7 0 1 3

Zweifach

4 2 7 0 1 3

Dreifach

4 3 7 0 1 3

Beispiel

4 1 7 0 1 3 0 1 0



# Kettenradscheibe

## 1" x 17,02 mm

für Rollenkette  
nach DIN 8187

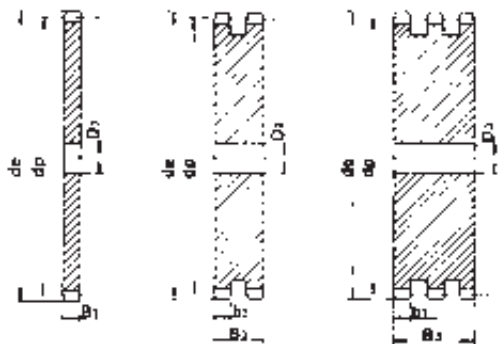

- Teilung = 25,4 mm
- Rollen ø = 15,88 mm
- r3 = 26 mm
- C = 2,5 mm
- B1 = 16,2 mm
- b1 = 15,8 mm
- B2 = 47,7 mm
- B3 = 79,6 mm

Material: C 43

Z	de	dp	Einf.			Zwei.			Drei.		
			D1	D2	D3	D1	D2	D3	D1	D2	D3
8	77,0	66,37	14	16	20						
9	85,0	74,27	14	16	20						
10	93,0	82,19	15	16	20						
11	99,5	90,14	15	20	25						
12	109,0	98,14	15	20	25						
13	117,0	106,12	15	20	25						
14	125,0	114,15	15	20	25						
15	133,0	122,17	15	20	25						
16	141,0	130,20	19	20	30						
17	149,0	138,22	19	20	30						
18	157,0	146,28	19	20	30						
19	165,2	154,33	19	20	30						
20	173,0	162,38	19	20	30						
21	181,2	170,43	20	25	30						
22	189,3	178,48	20	25	30						
23	197,5	186,53	20	25	30						
24	205,5	194,59	20	25	30						
25	213,5	202,66	20	25	30						
26	221,6	210,72	20	25	30						
27	229,6	218,79	20	25	30						
28	237,7	226,85	20	25	30						
29	245,8	234,92	20	25	30						
30	254,0	243,00	20	25	30						
31	262,0	251,08	25	25	30						
32	270,0	259,13	25	25	30						
33	278,5	267,21	25	25	30						
34	287,0	275,28	25	25	30						
35	296,2	283,36	25	25	30						
36	304,6	291,44	25	25	30						
37	312,6	299,51	25	25	30						
38	320,7	307,59	25	25	30						
39	328,8	315,67	25	25	30						
40	336,9	323,75	25	25	30						
41	345,0	331,82	25								
42	353,0	339,90	25	25	30						
43	361,1	347,98	25	25							
44	369,1	356,06	25	25	30						
45	377,1	364,13	25	25	30						
46	385,2	372,21	25	30	30						
47	393,2	380,29	25								
48	401,3	388,36	25	30	30						
49	409,3	396,44	25								
50	417,4	404,52	25	30	30						
51	425,5	412,60	30	30	40						
52	433,6	420,67	30	30	40						
53	441,7	428,75	30								
54	448,3	436,85	30								
55	457,9	444,93	30	30	40						
56	466,0	453,01	30	30							
57	474,0	461,07	30	30	40						
58	482,1	469,16	30								
59	490,2	477,24	30								
60	498,3	485,32	30	30	40						
62	514,5	501,50	30	30							
64	530,7	517,65	30								
65	538,8	525,73	30	30	40						
66	546,8	533,80	30								
68	562,9	549,98	30	30	40						
70	579,2	566,14	30	30	40						
72	595,4	582,32	30	30	40						
75	619,7	606,55	30	30	40						
76	627,0	614,65	30	30	40						
78	643,3	630,80	30								
80	660,0	646,96	30	30	40						
85	699,9	687,40	30	30	40						
90	740,3	727,81	30	30	40						
95	781,1	768,22	30	30	40						
100	821,1	808,63	30	30	40						
110	902,0	889,48	30	30	40						
114	934,3	921,81	30	40	40						
120	982,8	970,33	30	40	40						
125	1023,2	1010,73	30	40	40						

Bestell-Nr. zzgl. Zähnezahl

Einfach

4 1 7 0 1 4

Zweifach

4 2 7 0 1 4

Dreifach

4 3 7 0 1 4

Beispiel

4 1 7 0 1 4 0 1 0

## Kettenradscheibe

1 1/4" x 3/4"

für Rollenkette  
nach DIN 8187

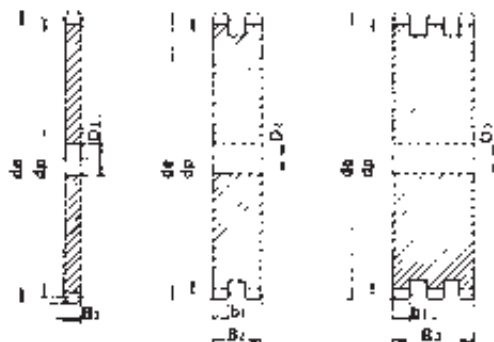
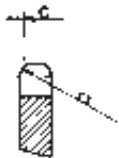

Teilung = 31,75 mm  
 Rollen ø = 19,05 mm  
 r3 = 32 mm  
 C = 3,5 mm  
 B1 = 18,5 mm  
 b1 = 18,2 mm  
 B2 = 54,6 mm  
 B3 = 91 mm

Material: C 43

Z	de	dp	Einf.			Zwei.			Drei.		
			D1	D2	D3	D1	D2	D3	D1	D2	D3
8	98,1	82,96	16	20	20						
9	108,0	92,84	16	20	20						
10	117,9	102,74	16	20	20						
11	127,8	112,68	16	20	20						
12	137,8	122,68	20	20	20						
13	147,8	132,65	20	20	20						
14	157,8	142,68	20	20	20						
15	167,9	152,72	20	20	20						
16	177,9	162,75	25	25	25						
17	187,9	172,78	25	25	25						
18	198,0	182,85	25	25	25						
19	208,1	192,91	25	25	25						
20	218,1	202,98	25	25	25						
21	228,2	213,04	25	25	25						
22	238,3	223,11	25	25	25						
23	248,3	233,17	25	25	25						
24	258,4	243,23	25	25	25						
25	268,5	253,33	25	25	25						
26	278,6	263,40	25	25	25						
27	288,6	273,40	25	25	25						
28	298,7	283,56	25	25	25						
29	308,8	293,65	25	25	25						
30	318,9	303,75	25	25	25						
31	329,0	313,85	25	25	30						
32	339,1	323,91	25	25	30						
33	349,2	334,01	25	25	30						
34	359,3	344,10	25	25	30						
35	369,4	354,20	25	25	30						
36	379,5	364,30	25	30	30						
37	389,5	374,39	25	30	30						
38	399,6	384,49	25	30	30						
39	409,7	394,59	25	30	30						
40	419,8	404,68	25	30	30						
41	429,9	414,78	30								
42	440,0	424,88	30	30	40						
43	450,1	434,97	30								
44	460,2	445,07	30								
46	470,3	455,17	30	30	40						
46	480,4	465,26	30	30	40						
47	490,5	475,36	30								
48	500,6	485,46	30	30	40						
49	510,7	495,55	30								
50	520,8	505,65	30	30	40						
51	530,9	515,75	30								
52	541,0	525,84	30	30	40						
53	551,1	535,94	30								
54	561,2	546,07	30								
55	571,3	556,16	30	30	40						
56	581,4	566,26	30								
57	591,5	576,36	30	30	40						
58	601,6	586,45	30								
59	611,7	596,55	30								
60	621,8	606,65	30	30	40						
62	642,0	626,87	30								
64	662,2	647,06	30								
65	672,3	657,16	30	30	40						
66	682,4	667,26	30								
68	702,6	687,48	30								
70	722,8	707,67	30	30	40						
72	743,1	727,90	30								
75	773,3	758,19	30								
76	783,5	768,32	30	30	40						
80	823,9	808,72	30	30	40						
85	874,4	859,25	30								
90	924,9	909,76	30								
95	975,4	960,28	30	30	40						
100	1026	1010,79	30								
114		1167,4	152,25	30	40						
40											

Bestell-Nr. zzgl. Zähnezahl

Einfach

4 1 7 0 1 5

Zweifach

4 2 7 0 1 5

Dreifach

4 3 7 0 1 5

Beispiel

4 1 7 0 1 5 0 1 0



## Kettenradscheibe

1 1/2" x 1"

für Rollenkette  
nach DIN 8187

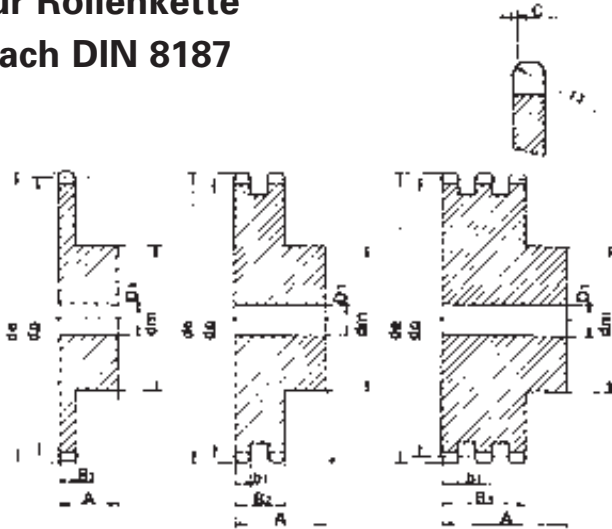

Teilung	=	38,1	mm
Rollen ø	=	25,4	mm
r3	=	38	mm
C	=	4	mm
B1	=	23,6	mm
b1	=	10,8	mm
B2	=	72	mm
B3	=	120,3	mm

Material: C 43

Z	de	dp	Einf.			Zwei.			Drei.		
			D1	D2	D3	D1	D2	D3	D1	D2	D3
8	115,0	99,55	20	25	25						
9	126,4	111,40	20	25	25						
10	138,0	123,29	20	25	25						
11	150,0	135,21	20	25	25						
12	162,0	147,22	20	25	25						
13	174,2	159,18	20	25	25						
14	186,2	171,22	20	25	25						
15	198,2	183,26	20	25	25						
16	210,3	195,30	25	25	25						
17	222,3	207,34	25	25	25						
18	234,3	219,42	25	25	25						
19	246,5	231,49	25	25	25						
20	258,6	243,57	25	25	25						
21	270,6	255,65	25	25	30						
22	282,7	267,73	25	25	30						
23	294,8	279,80	25	25	30						
24	306,8	291,88	25	25	30						
25	319,0	304,00	25	25	30						
26	331,0	316,08	30	30	30						
27	343,2	328,19	30	30	30						
28	355,2	340,27	30	30	30						
29	367,3	352,38	30	30	30						
30	379,6	364,50	30	30	40						
31	391,6	376,62	30	30							
32	403,7	388,69	30	30	40						
33	415,8	400,81	30	30	40						
34	427,8	412,93	30	30	40						
35	440,0	425,04	30	30	40						
36	452,0	437,16	30	30	40						
37	464,2	449,27	30	30							
38	476,2	461,39	30	30	40						
39	488,5	473,50	30	30							
40	500,6	485,62	30	30	40						
41	512,6	497,74	30								
42	524,7	509,85	30	40	40						
43	536,8	521,97	30								
44	549,0	534,08	30								
45	561,2	546,20	30	40	40						
46	573,3	558,32	30	40	40						
47	585,4	570,43	30								
48	597,4	582,55	30	40	40						
49	609,5	594,66	30								
50	621,7	606,78	30	40	40						
51	633,8	618,89	30								
52	646,0	631,01	30								
53	658,0	643,13	30								
54	670,2	655,28	30								
55	682,3	667,40	30	40	40						
56	694,4	679,51	30								
57	706,5	691,63	30	40	40						
58	718,6	703,74	30								
59	730,7	715,86	30								
60	742,8	727,97	30	40	40						
62	767,2	752,24	40								
64	791,3	776,48	40								
65	803,4	788,59	40	40	40						
66	815,6	800,71	40								
68	839,8	824,98	40								
70	864,2	849,21	40								
72	888,4	873,48	40								
75	924,8	909,83	40								
76	936,9	921,98	40	40	40						
80	985,4	970,44	40								
85	1046,0	1031,10	40								
95	1167,3	1152,33	40								

Bestell-Nr. zzgl. Zähnezahl

Einfach

4 1 7 0 1 6

Zweifach

4 2 7 0 1 6

Dreifach

4 3 7 0 1 6

Beispiel

4 1 7 0 1 6 0 1 0